

4MP Network IR Fixed Dome Camera

IPC3614SR3-DPF28 (36)(60)



Key Features

Optics

- Day/night functionality
- Up to 120 dB WDR (Wide Dynamic Range)
- SmartIR, up to 30 m (98 ft) IR distance

Compression

- Ultra 265, H.265, H.264, MJPEG
- Embedded smart algorithm
- Triple streams
- 9:16 corridor format

Network

- ONVIF Conformance

Structure

- Wide temperature range: -35°C to 60°C (-31°F to 140°F)
- Wide voltage range of $\pm 25\%$
- 4 KV surge protection designed for network interface

- IP67

Specifications

	IPC3614SR3-DPF28	IPC3614SR3-DPF36	IPC3614SR3-DPF60
Camera			
Sensor	1/3", progressive scan,4.0 megapixel, CMOS		
Lens	2.8mm@F1.8	3.6mm@F1.8	6mm@F1.8
Angle of view(H)	104.4°	76.8°	49.9°
Shutter	Auto/Manual, 1/6~1/100000 s		
Minimum Illumination	Colour: 0.02 Lux (F1.8, AGC ON) 0 Lux with IR		
Day/Night	IR-cut filter with auto switch (ICR)		
Digital noise reduction	2D/3D DNR		
S/N	>52 dB		
IR Range	Up to 30m (98 ft) IR range		
Defog	Digital Defog		
WDR	120dB		
AWB(Auto white balance)	Auto/manual		
Gain Control	Auto/manual		
Video			
Video Compression	Ultra 265,H.265, H.264, MJPEG		
Frame Rate	Main Stream:4MP (2592×1520): Max. 20 fps, 4MP (2560×1440): Max. 25 fps, 3MP (2048×1520): Max. 30 fps; Sub Stream:2MP (1920×1080): Max. 30 fps; Third Stream:D1(720×576) : Max. 30fps		
HLC	Supported		
BLC	Supported		
9:16 Corridor Mode	Supported		
OSD	Up to 8 OSDs		
Privacy Mask	Up to 8 areas		
ROI	Up to 8 areas		
Motion Detection	Up to 4 areas		
Smart			
Behavior Detection	Intrusion, cross line, motion detection		
Intelligent Identification	Face detection, Defocus, Scene Change		
Statistical Analysis	People counting		
General Function	Watermark, IP Address Filtering, Tampering Alarm, Access Policy, ARP Protection, RTSP Authentication, User Authentication		
Network			
Protocols	IPv4, IGMP, ICMP, ARP, TCP, UDP, DHCP, PPPoE, RTP, RTSP, RTCP, DNS, DDNS, NTP, FTP, UPnP, HTTP, HTTPS, SMTP, 802.1x, SNMP		
Compatible Integration	ONVIF(Profile S), API		
Interface			
Network	1 RJ45 10M/100M Base-TX Ethernet		

General	
Power	12 V DC±25%, PoE (IEEE802.3 af)
	Power consumption: Max 5.5W
Dimensions (Ø x H)	Φ126 x 94 mm (Ø5.0" x 3.7")
Weight	0.33 kg (0.73lb)
Operating Conditions	-35°C ~ +60°C (-31°F ~ 140°F), Humidity:10%~ 95% RH(non-condensing)
Ingress Protection	IP67

Dimensions

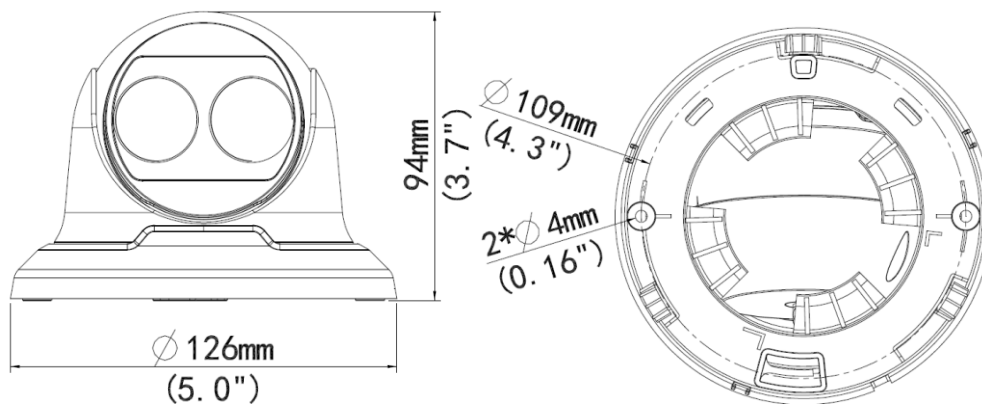

Zhejiang Uniview Technologies Co.,Ltd.

South Tower, Building 10, Wanlun Science Park, 88 Jiangling Road, Hangzhou, P.R.China 310051

Email: overseasbusiness@uniview.com; globalsupport@uniview.com

<http://www.uniview.com>

©2016 -2018 Zhejiang Uniview Technologies Co.,Ltd. All rights reserved.

*Product specifications and availability are subject to change without notice.